

- Gru a torre a braccio impennabile
- Luffing Jib Tower Crane • Grue à tour à flèche relevable
- Turmdrehkran mit Steilstellung-Ausleger
- Grúa torre de pluma abatible

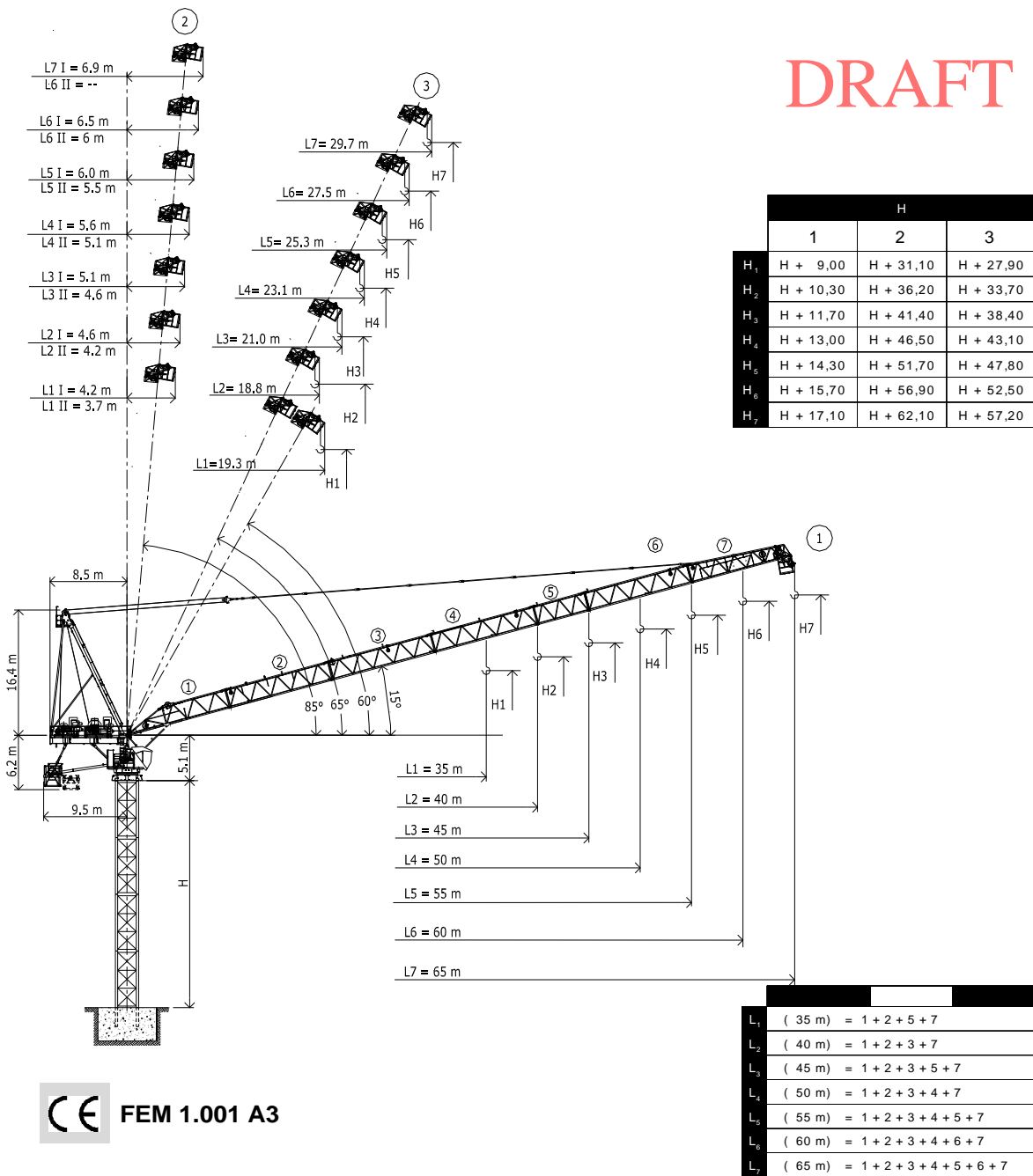

CE FEM 1.001 A3

CTL 650-32 HD23

Diagramma di portata **I** Courbes de charges **F** Curvas de cargas **E**
 Load Diagram **GB** Lastkurven **D**

CTL 650 - 32

Icon		Truss		m	15	20	25	30	35	40	45	50	55	60	65
16 t		30,1	m	t	16,00	16,00	16,00	16,00	13,68	11,87	10,46	9,34	8,41	7,65	7,00
16 t		36,7	m	t	16,00	16,00	16,00	16,00	16,00	14,65	12,93	11,56	10,43	9,50	(59,40m)
	24 t	24,1	m	t	24,00	24,00	23,11	18,99	16,05	13,84	12,12	10,75	9,63	8,80	
16 t		40,9	m	t	16,00	16,00	16,00	16,00	16,00	16,00	14,47	12,95	11,70	(54,40m)	
	24 t	26,7	m	t	24,00	24,00	24,00	21,25	17,98	15,53	13,63	12,11	11,00		
16 t		44,6	m	t	16,00	16,00	16,00	16,00	16,00	16,00	15,86	14,20	(49,40m)		
	32 t	22,2	m	t	32,00	32,00	28,24	23,26	19,71	17,05	14,97	13,50			
16 t		45,0	m	t	16,00	16,00	16,00	16,00	16,00	16,00	16,00	(44,40m)			
	32 t	22,4	m	t	32,00	32,00	28,59	23,56	19,96	17,27	15,40				
16 t		40,0	m	t	16,00	16,00	16,00	16,00	16,00	16,00	(39,40m)				
	32 t	22,9	m	t	32,00	32,00	29,29	24,14	20,46	18,00					
16 t		35,0	m	t	16,00	16,00	16,00	16,00	16,00	(34,4m)					
	32 t	23,3	m	t	32,00	32,00	29,78	24,55	21,20						

DRAFT

Altre installazioni **I** Autres implantations **F** Otras implantaciones **E**
 Other configurations **GB** Aufstellmöglichkeiten **D**

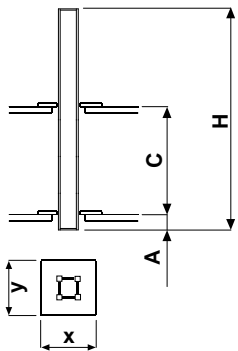

i

Gru climbing **I**
 Bottom climbing crane **GB**
 Télécopage sur dalles **F**
 Kletterkran im Gebäude **D**
 Grúa trepadora **E**

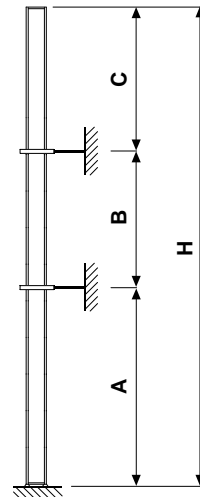

i

Gru ancorata **I**
 Crane tied to the structure **GB**
 Grue ancrée **F**
 Geankerter Kran **D**
 Grúa anclada **E**

Torre **I**
Tower **GB**
Tour **F**
Turm **D**
Torre **E**

DRAFT

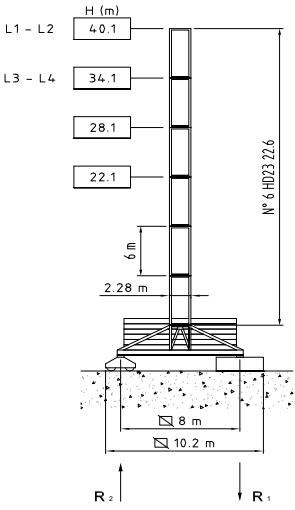

T₃-FP₃

R1	1600 kN ●	1300 kN ◄
R2		
	140 t	

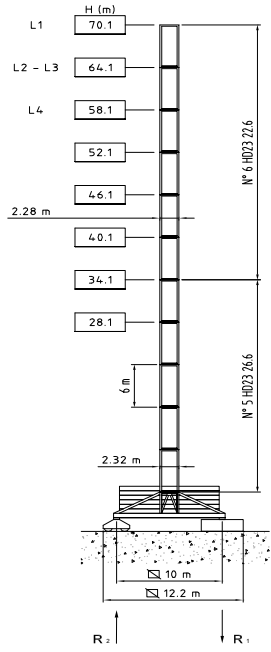

T₂-FP₂

R1	1900 kN ●	1800 kN ◄
R2		
	180 t	

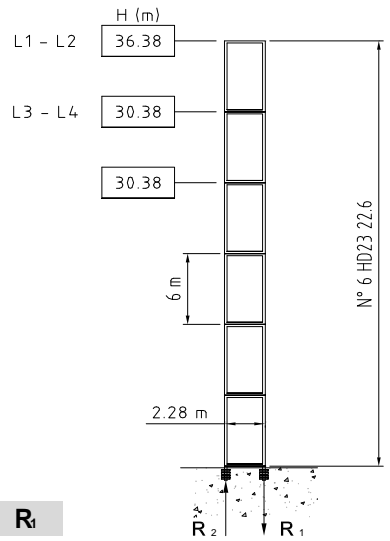

R₁

R1	3600 kN ●	3200 kN ◄
R2	2560 kN ●	2350 kN ◄
	116 t	

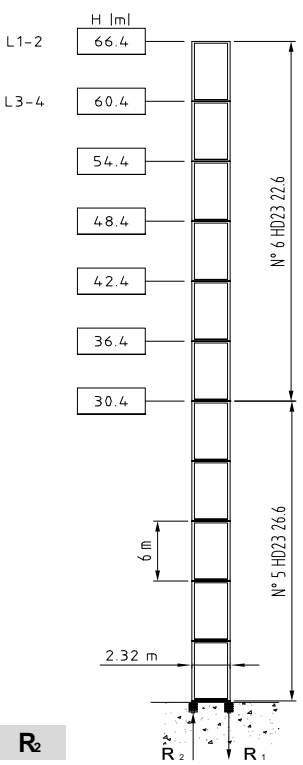

R₂

R1	4550 kN ●	5580 kN ◄
R2	3350 kN ●	4600 kN ◄
	148 t	

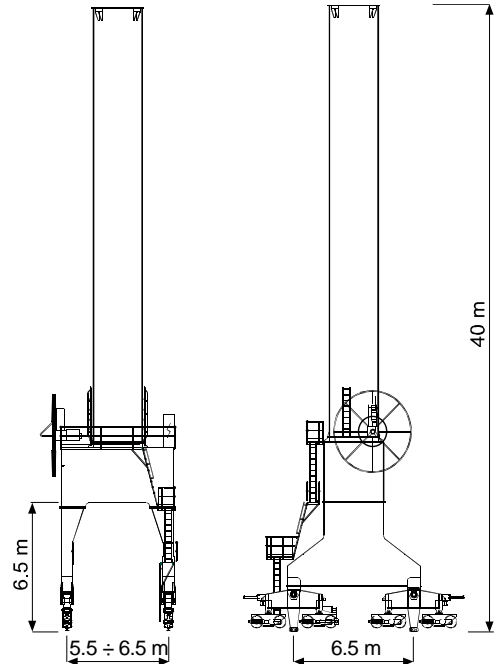

R1	●	●
R2	●	●
	250 t	

Meccanismi
Mechanisms



I
GB

Mécanismes
Antriebe





F
D









Mecanismos

E

			m/min	t	kw	
	132 AFC 160		0 ➔ 39	16	132	880 m
			0 ➔ 62	10		
			0 ➔ 72	7		
			0 ➔ 227	1,75		
			0 ➔ 19	32		
			0 ➔ 31	20		
			0 ➔ 36	14		
			0 ➔ 114	3,5		

DRAFT

	LFC 110 (VECTOR)	2,5 min	110 kW
	SCC 2 2 132 M	0 ⇌ 0,68 r.p.m.	2 × 18 kW
	TSR 2RG 4M 8	0 ⇌ 24 m/min	4 × 80 N m
			

	Sollevamento	I	Hoisting	GB	Levage	F	Heben	D	Elevación	E
	Brandeggio		Luffing		Relevage		Ausleger-Einziehen		Elevación de pluma	
	Rotazione		Slewing		Orientation		Schwenken		Orientación	
	Traslazione		Travelling		Translation		Schienerfahren		Traslación	
	Direttiva sul livello acustico		Directive on noise level		Directive sur le niveau acoustique		Richtlinie für den Schall-Leistungspegel		Directiva sobre el nivel acustico	
	Consultateci		Consult us		Nous consulter		Auf Anfrage		Consultarnos	
	Potenza totale richiesta		Power requirements		Puissance totale nécessaire		Geforderte Stromstärke		Potencia necesaria	
	Alimentazione		Power supply		Alimentation		Stromversorgung		Alimentación	

Terex Cranes

Dinglestrasse 24
66482 Zweibrücken - Germany
Tel: (+49) (0) 6332 830
Email: info.cranes@terex.com
Internet: www.comedil.com