

• **Gru a torre a braccio impennabile**
Luffing Jib Tower Crane • **Grue à tour à flèche relevable**
 • **Turmdrehkran mit Steilstellung-Ausleger**
 • **Grúa torre de pluma abatible**

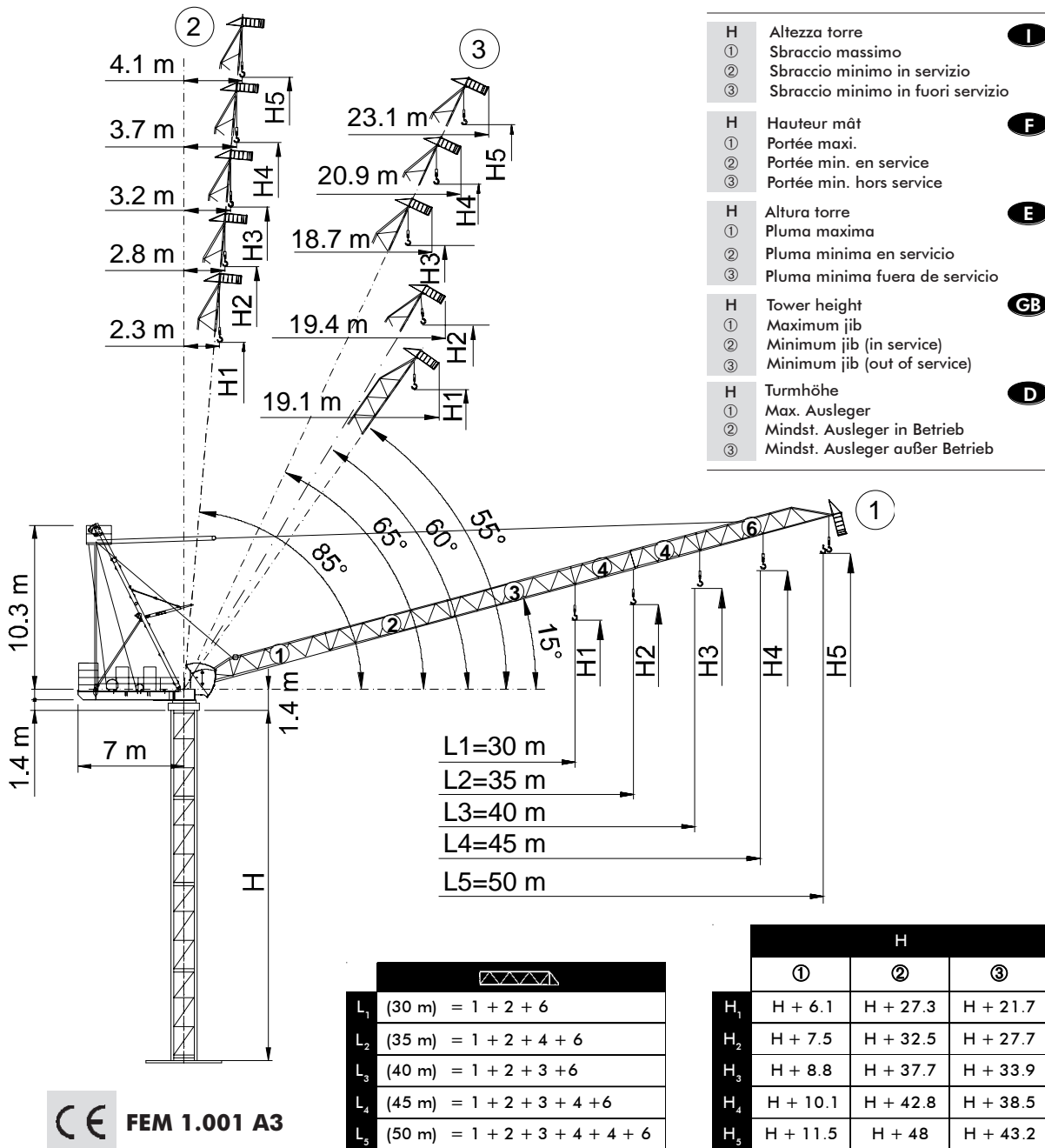

CTL 140-8 TS

Diagramma di portata I
Courbes de charges F
Curvas de cargas E
Load Diagram GB
Lastkurven D

CTL 140-8

		15	20	25	30	35	40	45	50
	4 t	4.00	4.00	4.00	4.00	3.60	2.85	2.27	1.80
	4 t	4.00	4.00	4.00	4.00	3.78	3.00	2.40	*
	6 t	6.00	6.00	6.00	4.92	3.88	3.10	2.50	
	8 t	8.00	8.00	6.25	4.81	3.78	3.00	2.40	
	4 t	4.00	4.00	4.00	4.00	3.97	3.20	*	
	6 t	6.00	6.00	6.00	5.11	4.07	3.30		
	8 t	8.00	8.00	6.45	5.01	3.97	3.20		
	4 t	4.00	4.00	4.00	4.00	4.00			
	6 t	6.00	6.00	6.00	5.33	4.30			
	8 t	8.00	8.00	6.68	5.23	4.20			
	4 t	4.00	4.00	4.00	4.00				
	6 t	6.00	6.00	6.00	5.50				
	8 t	8.00	8.00	6.84	5.40				

* = + 200 kg - 45 m - 40 m i

Altre installazioni I
Autres implantations F
Otras implantaciones E
Other configurations GB
Aufstellungsmöglichkeiten D

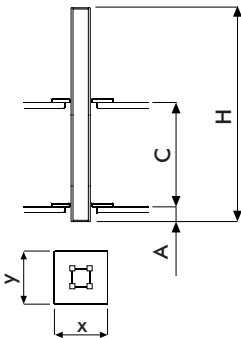

i

Gru climbing
 Bottom climbing crane
 Télésopage sur dalles
 Kletterkran im Gebäude
 Grúa trepadora

I
GB
F
D
E

		TS 16c									
		[m]									
		L ₁	L ₂	L ₃	L ₄	L ₅	L ₁₋₂	L ₃₋₄	L ₁	L ₂	
	C_{min}	13					11			9	
	H_{max}	44.3	41.3	38.4	35.4	32.5	35.4	29.5	35.4	29.5	
	A_{min}	2									
	x	2.3									
	y	1.8									

		TS 21c												
		[m]												
		L ₁	L ₂	L ₃	L ₄	L ₅	L ₁₋₂	L ₃₋₄	L ₅	L ₁	L ₂₋₃	L ₄₋₅	L ₁	L ₂₋₃
	C_{min}	15					13			11			9	
	H_{max}	50.2	47.2	44.3	41.3	38.4	41.3	35.4	29.5	38.4	35.4	29.5	35.4	29.5
	A_{min}	2												
	x	2.8												
	y	2.3												

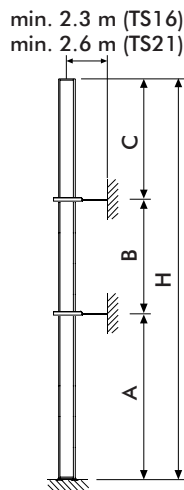

i

Gru ancorata
 Crane tied to the structure
 Grue ancrée
 Geankerter Kran
 Grúa anclada

I
GB
F
D
E

		TS 16 R1			TS 21 R2		
		[m]					
		L ₁₋₂	L ₃₋₄	L ₅	L ₁₋₂	L ₃₋₄	L ₅
	A_{min/max}	24/30	24/27	24/25	24/36	24/33	24/30
	B_{min/max}	17.7/23.6	17.7/23.6	17.7/23.6	17.7/23.6	17.7/23.6	17.7/23.6
	C_{max}	30	27	25	36	33	30
	H_{max}	i					

TS16

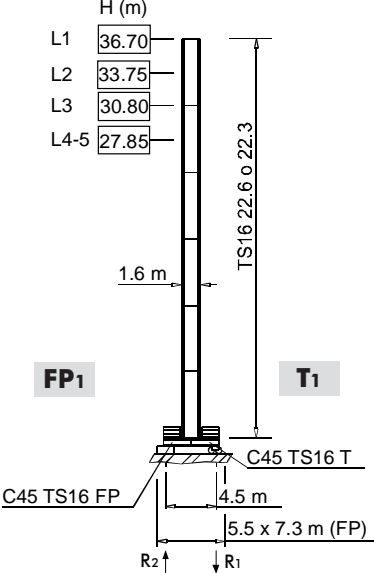

R1	890 kN	1100 kN
R2	-	-
	40 t (FP1)	

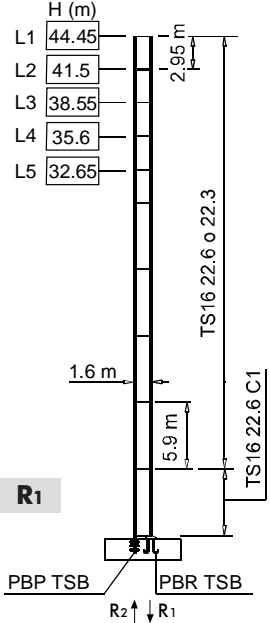

R1	1600 kN	2200 kN
R2	1200 kN	1950 kN
	40 t	

TS21

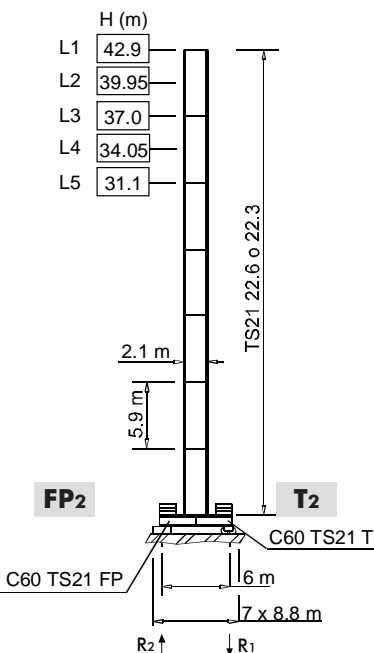

R1	750 kN	1000 kN
R2	-	-
	46 t (FP2)	

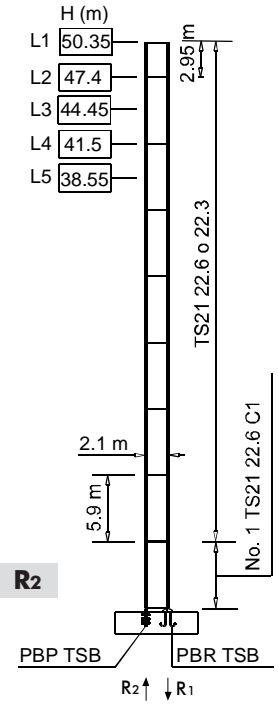

R1	1350 kN	2150 kN
R2	950 kN	1850 kN
	45 t	

H Altezza massima s. g. **I** Max. under hook height **GB** Hauteur maxi. sous crochet **F** Höchste Hackenhöhe **D** Maxima altura bajo gancho **E** In servizio In service En service In Betrieb En servicio
 ◆ Fuori servizio Out of service Hors service Außer Betrieb Fuera de servicio
 A vuoto, senza zavorra, braccio max., altezza max. Without load, without ballast, max. jib and max. height A vide, sans lest, avec flèche et hauteur maximum Ohne Last und Ballast, mit Maximalausleger und Maximalhöhe Sin carga, sin lastre, con pluma y altura máxima

Meccanismi
Mechanisms





Mécanismes
Antriebe













Mecanismos











		
79 * kVA	400 V - 50 Hz / 460 V - 60 Hz	2000/14/CE

* Gru senza traslazione / Crane without travelling equipment / Grue sans translation / Krane ohne Schienenfahren / Grúa sin traslación

		m/min	↑	kW	
		0 ⇒ 3	4	37	580 m (R00) 850 m (R01)
		0 ⇒ 11	4		
		0 ⇒ 44	4		
		0 ⇒ 80	2.1		
		0 ⇒ 116	1.3		
		0 ⇒ 2	6		
		0 ⇒ 7.3	6		
		0 ⇒ 29.3	6		
		0 ⇒ 53.3	3.15		
		0 ⇒ 77.3	1.95		
		0 ⇒ 1.5	8		
		0 ⇒ 5.5	8		
		0 ⇒ 22	8		
		0 ⇒ 40	4.2		
		0 ⇒ 58	2.6		

	LFC 37 R00 (VECTOR)	1.5 min	37 kW
	SCC 2 2 100S	0 ⇒ 0.75 r.p.m.	2 × 5.81 kW
	TAD 2RG 4M3	0 ⇒ 24 m/min	4 × 3 kW
			

	Sollevamento	I	Hoisting	GB	Levage	F	Heben	D	Elevación	E
	Brandeggio		Luffing		Relevage		Ausleger-Einziehen		Elevación de pluma	
	Rotazione		Slewing		Orientation		Schwenken		Orientación	
	Traslazione		Travelling		Translation		Schienenfahren		Traslación	
	Direttiva sul livello acustico		Directive on noise level		Directive sur le niveau acoustique		Richtlinie für den Schall-Leistungspegel		Directiva sobre el nivel acustico	
	Consultateci		Consult us		Nous consulter		Auf Anfrage		Consultarnos	
	Potenza totale richiesta		Power requirements		Puissance totale nécessaire		Geforderte Stromstärke		Potencia necesaria	
	Alimentazione		Power supply		Alimentation		Stromversorgung		Alimentación	

Gru Comedil s.r.l.

A Terex Company

Via S. Egidio 42/A, 33074 Fontanafredda (PN) - Italy
Tel. (+39) 0434 567 311 - Telefax (+39) 0434 998631

Internet e-mail: info@comedil.com

Internet home page: www.comedil.com

Divisione Automontanti

Via Alessandrina, 25 - 20095 Cusano Milanino (MI) - Italy
Tel. (+39) 02 613 16011 - Telefax (+39) 02 613 16034

Internet e-mail: info.CBR@comedil.com